

Mini Extension Ring 30

Please follow the instructions below to mount the Mini Extension Ring 30 on a port.

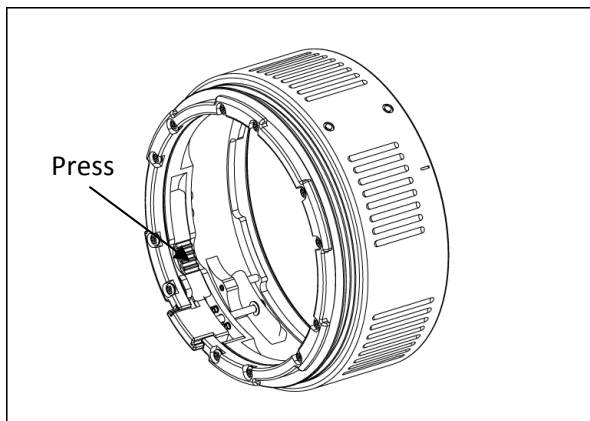

1. Press the RED bar to unlock the locking device of the extension ring.

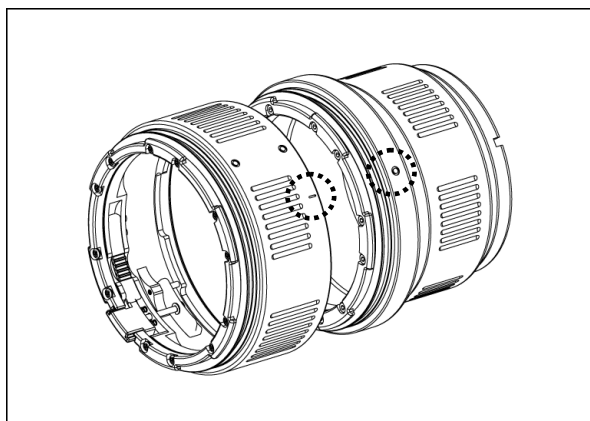

2. Align the "I" mark on the extension ring with the WHITE dot on the port.

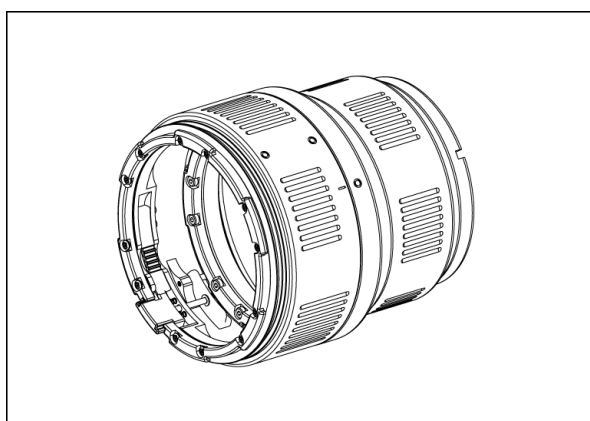

3. Gently push the extension ring towards the port until it cannot go any further.

Mini Extension Ring 30

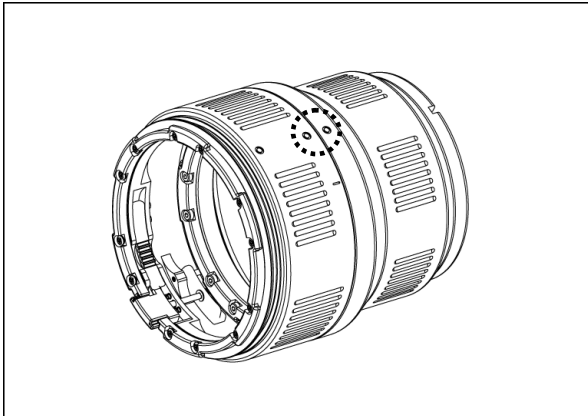

4. Turn the extension ring clockwise until the white dot on the extension ring aligns with the white dot on the port.

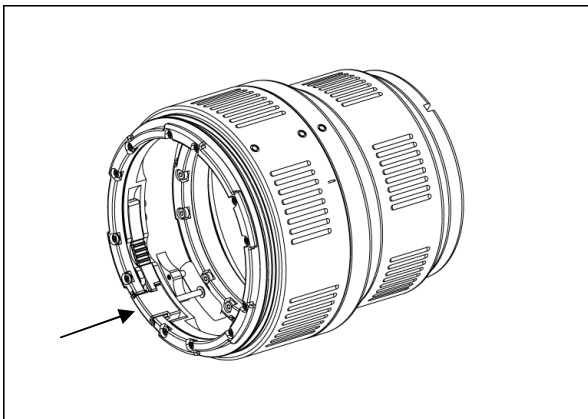

5. Push the locking device inwards. Ensure that the extension ring is securely locked with the port.

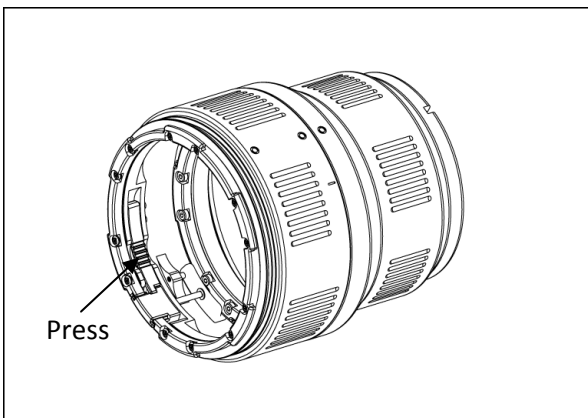

6. To unlock, press the RED bar to release the locking device and reverse the above procedures.